

RoHS
COMPLIANT

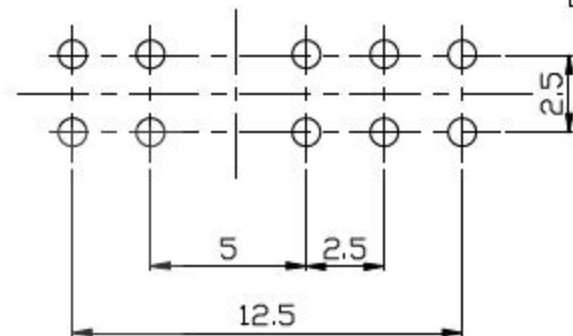

P.C.B LAYOUT

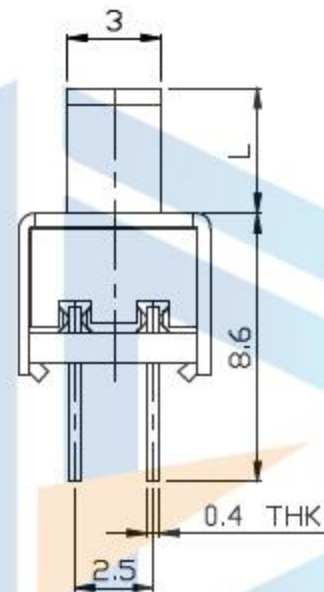
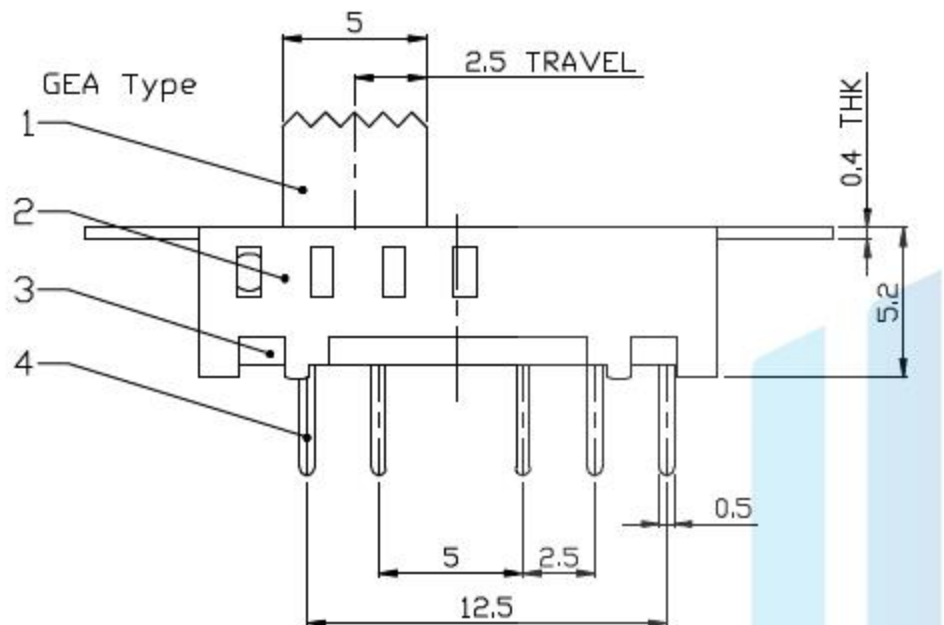
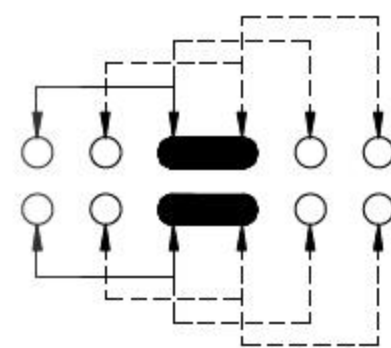

CIRCUIT DIAGRAM

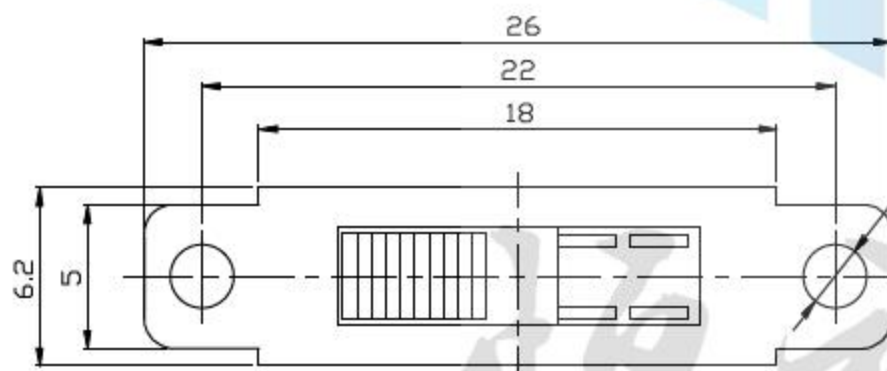

额定电压:DC 50V 0.3A
 接触电阻:30MΩ MAX 30毫欧以下
 绝缘电阻:100MΩ MIN 100兆欧以上
 耐压强度:AC500V (50/60Hz) 1分钟感度电流为0.5mA
 操作温度: -16°C ±60°C
 机械寿命: 10, 000 cycles

设计:	Arvin: 2016.03.08	范围 Range	公差 Tolerance
审核:	Arvin:	X.X ±	X.X ±0.30
校对:	Ru yi:	X.XX ±	X.XX ±0.20
比例:	视角关系:	X.XXX ±	X.XXX ±0.10
版次:	图框大小: A4	Angle ±	Angle ±5°

东莞市恒祺电子科技有限公司

名称:拨动开关 料号:

型号:SS-24E04

共 张 , 第 张

备注: