

电路图

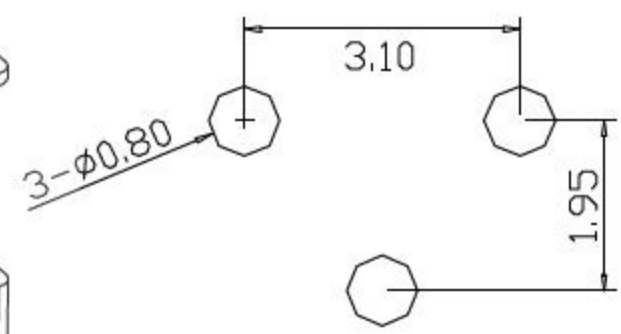

PCB. 焊接图

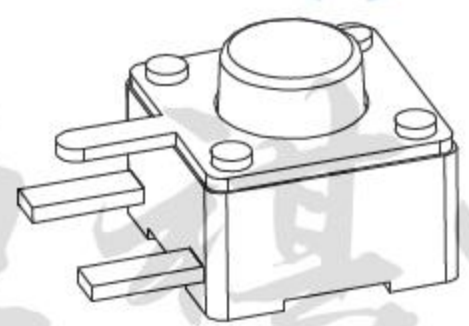

1. Operating temperature range: -30°C to 85°C
2. Rating: DC12V 50mA
3. Insulation resistance: $100\text{M}\Omega$ min 100V DC
4. Dielectric strength: 250V AC for 1min
5. Contact resistance: $100\text{m}\Omega$ Max
6. Operating force: $160 \pm 50\text{gf}$ - $260 \pm 50\text{gf}$
7. Travel: $0.25 \pm 0.10\text{mm}$
8. Operating life: 260gf 100,000 Cycle

设计:	Arvin: 2016.03.08	范围 Range	公差 Tolerance
审核:	Arvin:	X.X ±	X.X ±0.30
校对:	Ru yi:	X.XX ±	X.XX ±0.20
比例:	视角关系:	X.XXX ±	X.XXX ±0.10
版次:	图框大小: A4	Angle ±	Angle ±5°

东莞市恒祺电子科技有限公司

名称: 轻触开关 料号:
 型号: TS-C017
 共 张 , 第 张 备注: